



VSM100 Absolute and Differential Vacuum Switches *The Mini Bee™*



User Manual

InstruTech
1475 S. Fordham St.
Longmont, CO 80503
USA

Phone: +1-303-651-0551
Fax: +1-303-678-1754
E-mail info@instrutechinc.com
www.instrutechinc.com

Important User Information

All persons that apply this equipment must take every precaution and satisfy themselves that the intended application of this equipment is safe and used in an acceptable manner. In no event will InstruTech be responsible or liable for indirect or consequential damages that result from the use or application of this equipment.

Any examples or diagrams included in this manual are provided solely for illustrative purposes. Because of the many variables and requirements imposed on any particular installation, InstruTech cannot assume responsibility or liability for any actual use based on the examples and diagrams. No patent liability is assumed by InstruTech with respect to use of information circuits, equipment, or software described in this manual.

Throughout this manual we use notes, notices and apply internationally recognized symbols and safety messages to make you aware of safety considerations.

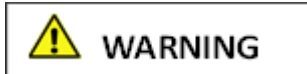

Identifies information about practices or circumstances that can cause electrical or physical hazards which, if precautions are not taken, could result in death or serious injury, property damage, or economic loss.



Identifies information about practices or circumstances that can cause electrical or physical hazards which, if precautions are not taken, could result in minor or moderate injury, property damage, or economic loss.

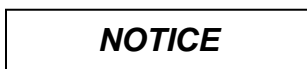

Identifies information that is critical for successful application and understanding of the product.



Labels may be located on or inside the device to alert people that dangerous voltages may be present.

Copyright © 2016 by InstruTech

All rights reserved. No part of this work may be reproduced or transmitted in any form or by any means, electronic or mechanical, including photocopying and recording, or by any information storage or retrieval system, except as may be expressly permitted in writing by InstruTech.

Printed in the United States of America

Swagelok®, VCO®, VCR® are registered trademarks of Swagelok Co., Solon, OH

Table of Contents

1	Introduction / General Information	3
1.1	Description	3
1.2	Specifications	3
1.3	Dimension	4
1.4	Part Numbers	4
1.5	Options & Accessories.....	6
2	Important Safety Information.....	7
2.1	Safety Precautions – General.....	7
2.2	Safety Precautions - Service and operation	8
2.3	Electrical Conditions.....	8
2.3.1	Proper Equipment Grounding	8
2.3.2	Electrical Interface and Control.....	9
2.4	Overpressure and use with hazardous gases.....	9
3	Installation	10
3.1	Mechanical Installation	10
3.2	Electrical Installation	11
3.2.1	Grounding.....	11
3.2.2	Electrical Connections	11
3.2.3	Setpoint.....	12
4	Service.....	13
4.1	Maintenance	13
4.1.1	Removing the switch from service	13
5	Factory Service and Support.....	14
6	Warranty.....	14

1 Introduction / General Information

1.1 Description

The VSM100 *Mini Bee*TM is a cleanroom compliant all stainless steel corrosion resistant vacuum switch. It is a high-accuracy, temperature compensated sensor designed for accurate and reliable pressure detection in vacuum applications including pressure interlocks. The *Mini Bee* is available in an absolute and differential configuration. The absolute switch has a full scale rating of 1000 Torr and the setpoint relay can be preset to any user specified value from 20 to 970 Torr. The differential switch setpoint can be preset set from 99 Torr below atmospheric pressure up to 46 Torr above atmospheric pressure.

1.2 Specifications

	VSM100A Absolute Vacuum Switch	VSM100D Differential Vacuum Switch
full Scale	1,000 Torr absolute	150 Torr differential
differential range	N/A	-100 to +50 Torr (relative to atm.)
setpoint range	20 to 970 Torr	-99 to + 46 Torr (relative to atm.)
setpoint accuracy	0.5% F.S.	0.5% F.S.
setpoint relay contact rating	≤30 V (dc) / 1 A (dc) ≤30 V (ac) / 0.3 A (ac)	≤30 V (dc) / 1 A (dc) ≤30 V (ac) / 0.3 A (ac)
resolution	10 bit	10 bit
response time	≤ 45 ms	≤ 45 ms
hysteresis	2% F.S. above setpoint	2% F.S. above setpoint
temperature effect on zero & span	≤ ±0.02% F.S. / °C	≤ ±0.02% F.S. / °C
materials exposed to vacuum	stainless steel	stainless steel
internal volume		
	NW16KF	0.17 in ³ (2.81 cm ³)
	4VCR	0.057 in ³ (0.93 cm ³)
weight	4.94 oz. (140 g)	4.94 oz. (140 g)
operating temperature	0 to +70 °C	0 to +70 °C
storage temperature	-40 to 80 °C	-40 to 80 °C
humidity	0 to 85% relative humidity up to 31 °C decreasing to 50% at +40 °C	0 to 85% relative humidity up to 31 °C decreasing to 50% at +40 °C
admissible pressure (absolute)	72.5 psi (5 bar)	29 psi (2 bar)
service life	>1×10 ⁸ cycles	>1×10 ⁸ cycles
	electronics	25,000 hours
	relay	>3×10 ⁶ cycles
altitude	13,125 ft.(4,000 m) max	13,125 ft.(4,000 m) max
use	indoor only	Indoor only
mounting orientation ¹⁾	any	any
input power ²⁾	14 to 30 Vdc, 0.5 W	14 to 30 Vdc, 0.5 W
CE compliance	EN 61000-4-3:2006	EN 61000-4-3:2006

	EN 61010-1:2010	EN 61010-1:2010
environmental	RoHS	RoHS

1) The gauge is factory calibrated while "standing upright". A different mounting orientation could result in a low zero drift of 0.05 % F.S.

(2) **⚠ WARNING!** The gauge may only be connected to power supplies, instruments, or control devices that conform to the requirements of a grounded protective extra-low voltage (SELV) and limited power source (LPS), Class 2. The connection to the gauge has to be fused.

1.3 Dimension

in. (mm)

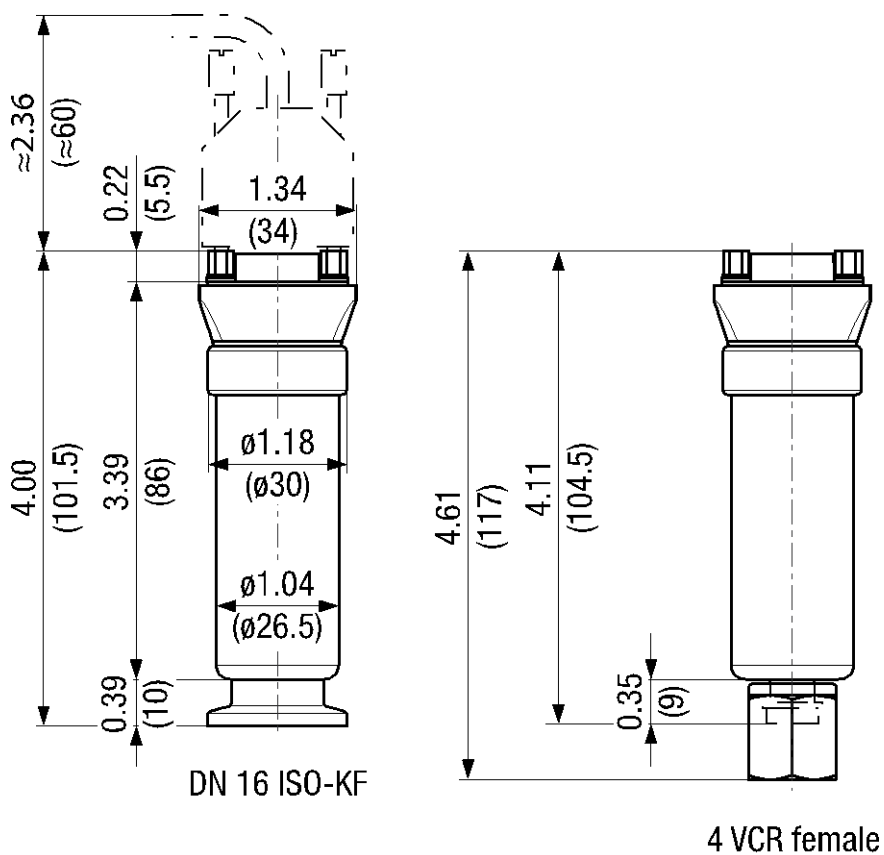

1.4 Part Numbers

VSM100A Absolute Vacuum Switch

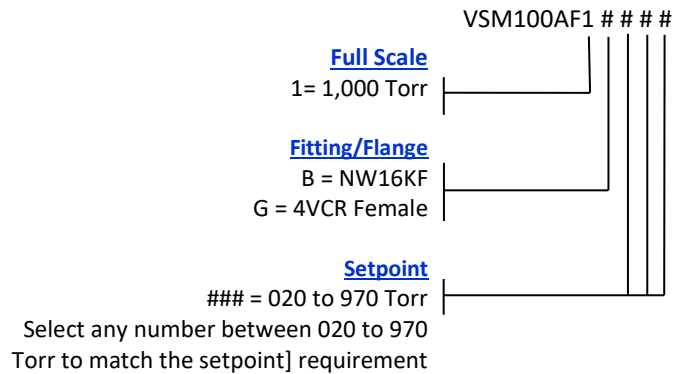

Example: VSM100AF1G030 (Absolute vacuum switch with 4VCR fitting, setpoint at 30 Torr)

VSM100D Differential Vacuum Switch

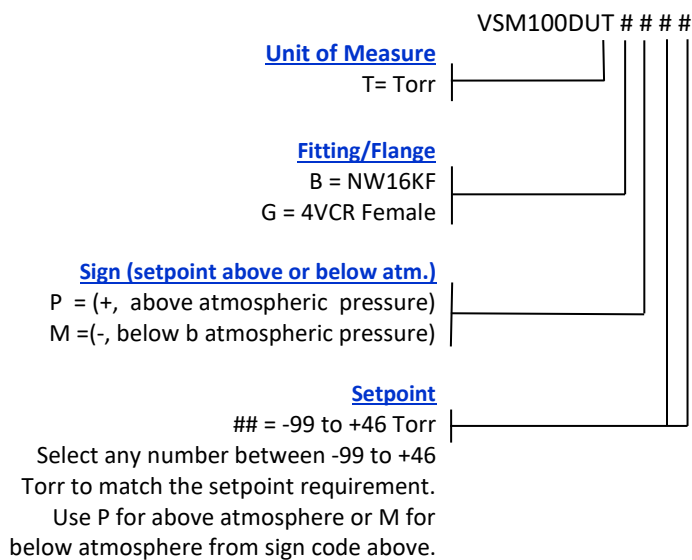

Example: VSM100DUTGP40 (Differential vacuum switch, Torr, 4VCR fitting, setpoint 40 Torr above atmospheric pressure)

1.5 Options & Accessories

Optional Wall Mount AC-DC

PS101 Power Supply

Input: 100 - 240 Vac

Output: 24 Vdc @ 750 mA (18 W)

Various AC plugs, 6 ft. cable length



PS101-UX For Use With User Supplied AC Power Cord



		Part Number
with North American AC Plug		PS101-A
with Universal European AC Plug		PS101-EU
with UK AC Plug		PS101-UK
with China AC Plug		PS101-C
with Australian AC Plug		PS101-SP

This variation of the PS101 power supply may be used when an AC plug that is not listed above is required. The conventional IEC60320 AC power entry receptacle allows use with any user supplied AC mains power cord set available worldwide.

PS101-UX

Input: 100 - 240 Vac
Output: 24 Vdc @ 2.5 A (60 W)
Cable Length: 6 ft.

2 Important Safety Information

InstruTech has designed and tested this product to provide safe and reliable service, provided it is installed and operated within the *strict safety guidelines provided in this manual*. **Please read and follow all warnings and instructions.**





To avoid serious injury or death, follow the safety information in this document. Failure to comply with these safety procedures could result in serious bodily harm, including death, and or property damage.

Failure to comply with these warnings violates the safety standards of installation and intended use of this instrument. InstruTech disclaims all liability for the customer's failure to comply with these instructions.

Although every attempt has been made to consider most possible installations, InstruTech cannot anticipate every contingency that arises from various installations, operation, or maintenance of the product. If you have any questions about the safe installation and use of this product, please contact InstruTech.

2.1 Safety Precautions – General

 **WARNING!** Do not modify this product or substitute any parts without authorization of qualified InstruTech service trained personnel. Return the product to an InstruTech qualified service and repair center to ensure that all safety features are maintained. Do not use this product if unauthorized modifications have been made.

 **WARNING!** Source power must be removed from the product prior to performing any servicing.

 **WARNING!** The vacuum switch may only be connected to power supplies, instruments or control devices that conform to the requirements of a grounded extra-low voltage. The connection to the vacuum switch has to be fused.

After servicing this product, ensure that all safety checks are made by a qualified service person. Use of unauthorized parts or modifications made to this product will void the warranty.

To reduce the risk of fire or electric shock, do not expose this product to rain or moisture. These products are not waterproof and careful attention must be paid to not spill any type of liquid onto these products. Do not use these products if they have been damaged. Immediately contact InstruTech to arrange return of the product if it is damaged.

Due to the possibility of corrosion when used in certain environmental conditions, it is possible that the product's safety could be compromised over time. It is important that the product be periodically inspected for sound electrical connections and equipment grounding. Do not use if the equipment grounding or electrical insulation has been compromised.

2.2 Safety Precautions - Service and operation

Ensure that the vacuum port on which the VSM100 switch is mounted is electrically grounded.

Use an appropriate power source of 14 to 30 Vdc, 0.52 W.

Turn off power to the unit before attempting to service the module.

Turn off power to the unit if a cable or plug is damaged or the product is not operating normally according to this instruction manual. Contact qualified InstruTech service personnel for any service or troubleshooting condition that may not be covered by this instruction manual.

It is important that the product be periodically inspected for sound electrical connections and equipment grounding. Do not use if the equipment grounding or electrical insulation has been compromised.

Do not use if the unit has been dropped or the enclosure has been damaged.

2.3 Electrical Conditions

 **WARNING!** When high voltage is present in any vacuum system, a life threatening electrical shock hazard may exist unless all exposed electrical conductors are maintained at earth ground potential. This applies to all products that come in contact with the gas contained in vacuum chambers. An electrical discharge within a gaseous environment may couple dangerous high voltage directly to any ungrounded conductor of electricity. A person could be seriously injured or killed by coming in contact with an exposed, ungrounded electrical conductor at high voltage potential. This condition applies to all products that may come in contact with the gas inside the vacuum chamber (vacuum/pressure containment vessel).

2.3.1 Proper Equipment Grounding

 **WARNING!** Hazardous voltages that could seriously injure or cause death are present in many vacuum processes. Verify that the vacuum port on which the VSM100 vacuum switch is mounted is electrically grounded. Consult a qualified Electrician if you are in doubt about your equipment grounding. Proper grounding of your equipment is essential for safety as well as intended operation of the equipment.

The VSM100 must be electrically connected to the grounded vacuum chamber. The connection must conform to the requirements of a protective connection according to EN 61010:

- VCR® connections fulfill this requirement
- For gauges with a KF connection, use a conductive metallic clamping ring.

 **WARNING!** In order to protect personnel from electric shock and bodily harm, shield all conductors which are subject to potential high voltage electrical discharges in or around the vacuum system.

2.3.2 Electrical Interface and Control

It is the user's responsibility to ensure that the electrical signals from this product and any connections made to external devices, for example, relays and solenoids, are used in a safe manner. Always double check the system set-up before using any signals to automate your process. Perform a hazardous operation analysis of your system design and ensure safeguards and personnel safety measures are taken to prevent injury and property damage.

2.4 Overpressure and use with hazardous gases

 **WARNING!** Install suitable protective devices that will limit the level of pressure inside your vacuum chamber to less than what the vacuum chamber system components are capable of withstanding. For example, a quick-connect, O-ring compression fitting may forcibly release a mounted device from the vacuum chamber fitting with only a few psi over local uncorrected barometric (atmospheric) pressure.

In cases where an equipment failure could cause a hazardous condition, always implement fail-safe system operation. For example, use a pressure relief device in an automatic backfill operation where a malfunction could result in high internal pressures if the pressure relief device was not installed on the chamber.

 **WARNING!** Overpressure in the vacuum system > 14.5 psia (1 bar)

Injury caused by released parts and harm caused by escaping process gases can result if clamps are opened while the vacuum system is pressurized. Do not open any clamps while the vacuum system is pressurized. Use the type of clamps which are suited to overpressure.

 **WARNING!** Overpressure in the vacuum system > 29 psia (2.5 bar)

KF connections with elastomer seals (O-rings) cannot withstand such pressures. Process media can thus leak and possibly damage your health. Use O-rings provided with an outer centering ring.

 **CAUTION!** If the internal pressure of a vacuum measuring device is allowed to increase above local uncorrected barometric pressure (atmospheric pressure side), vacuum fittings may release and possible overpressure conditions may cause leaks that would allow the gas inside the tube to release into the atmosphere of the surrounding environment. Toxic, pyrophoric and flammable gases are examples of hazardous gases that if allowed to leak out of the vacuum/pressure containment vessel into the atmospheric environment, could cause bodily injury and possible damage to equipment. Never expose the vacuum measuring device internal volume to pressure above local atmospheric pressure when using hazardous gases.

3 Installation

3.1 Mechanical Installation

⚠ CAUTION! Dirt and damage can impair the function of the vacuum component. Take appropriate measures to ensure cleanliness and prevent damage. Touching the product or parts with bare hands increases the desorption rate. Always use clean, lint free gloves as well as clean tools when working with this product.

Remove the protective lid and install the product to the vacuum system following manufacturer's recommendations for different flanges and fittings. Keep the protective lid for future maintenance.

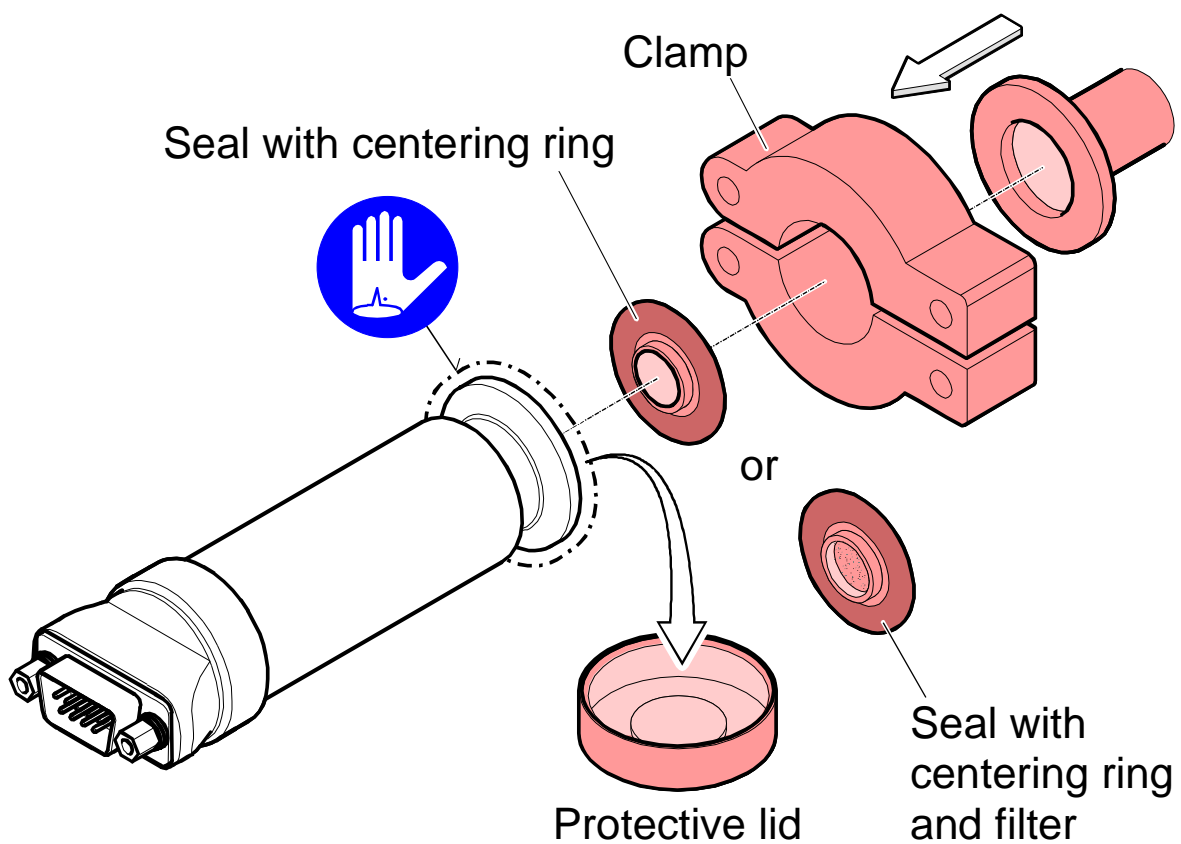

3.2 Electrical Installation

3.2.1 Grounding

⚠ WARNING! Be sure the vacuum switch and the rest of your vacuum system are properly grounded for safety as well as intended operation of the equipment. When using KF flanges, metal clamps must be used to ensure proper grounding.

3.2.2 Electrical Connections

A good recommended practice is to remove power from any cable prior to connecting or disconnecting it.

1) Fabricate a cable to connect to the vacuum switch as shown below:

9-pin D-sub Connector pinout

PIN NUMBER	PIN DESCRIPTION
1	Power Ground
2	Power Input (14-30 Vdc)
3	Relay Normally Open
4	Relay Common
5	Relay Normally Closed
6*	Internal Communications RxD
7*	Internal Communications TxD
8*	Internal Communications Common
9	Housing (Chassis Ground)

* The setpoint has been preset in the factory per user specifications. The communications pins (6 thru 8) are used if it becomes necessary to reconfigure the setpoint in the field. A communications adapter with software can be purchased from InstruTech to perform this task.

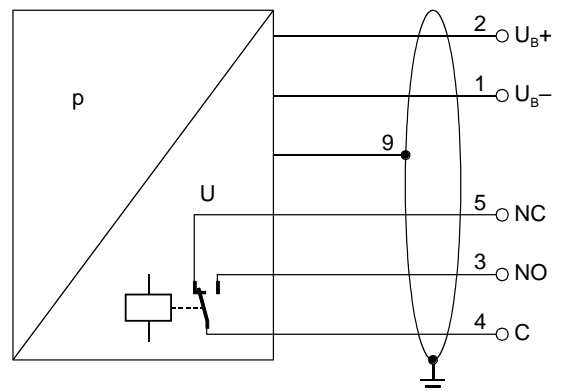

2. Connect the cable to the vacuum switch.

3.2.3 Setpoint

With the VSM100A absolute vacuum switch the relay will turn on (energize) if the pressure in the vacuum system drops below the setpoint. The relay will turn off (de-energize) when the pressure rises 2% (hysteresis) above the setpoint.

With the VSM100D differential vacuum switch the relay will turn on (energize) when the differential pressure between the chamber and atmospheric pressure reaches the setpoint. If relay is configured to turn on at a setpoint value when chamber pressure is lower than atmospheric pressure, relay will turn off when differential pressure rises 2% (hysteresis) above the setpoint. If relay is configured to turn on at a setpoint value when chamber pressure is higher than atmospheric pressure, relay will turn off when differential pressure drops 2% (hysteresis) below the setpoint.

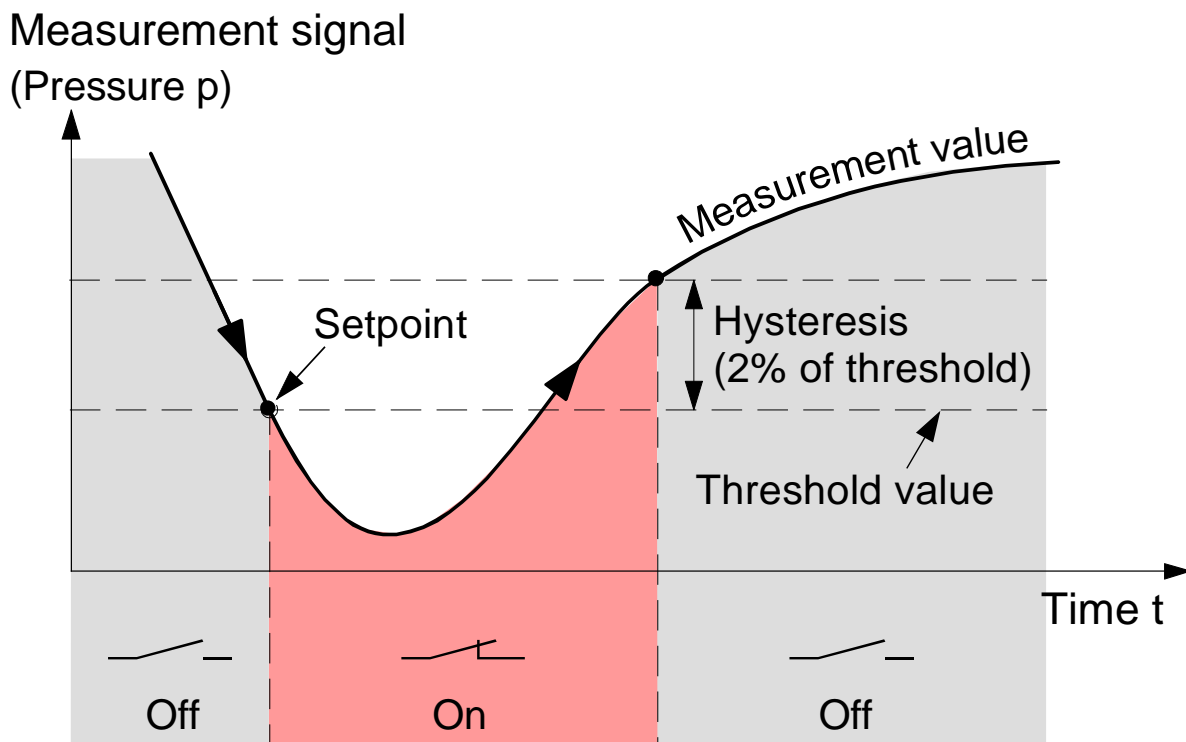

4 Service

4.1 Maintenance

In general, under clean operating conditions, maintenance is not required for your InstruTech vacuum switch. The product is factory calibrated while 'standing upright'. Over long time operation, using in another orientation or contamination may mean that a zero adjustment is necessary. Return the product to InstruTech for service if necessary.

4.1.1 Removing the switch from service

⚠ WARNING! Contaminated parts can be detrimental to health. Before beginning work, find out whether parts are contaminated and adhere to the relevant regulations and precautions for handling contaminated parts.

⚠ CAUTION! Dirt and damage impair the function of the vacuum component. Take appropriate measures to ensure cleanliness and prevent damage. Touching the product or parts with bare hands increases the desorption rate. Always use clean, lint free gloves as well as clean tools when working with this product.

- 1) Vent the vacuum system and turn off power to the switch.
- 2) Unplug the sensor cable and remove the switch from the chamber.
- 3) Re-install the protective lid.

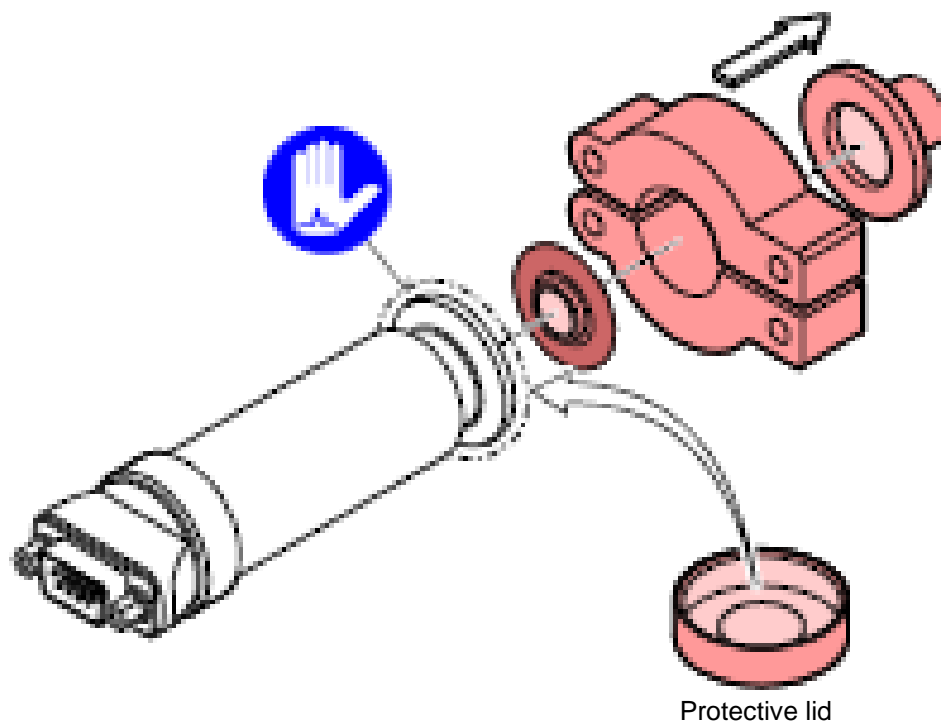

5 Factory Service and Support

If you need help setting up, operating, troubleshooting, or obtaining a return materials authorization number (RMA number) to return the module for diagnosis, please contact us during normal business hours (8:00am to 5:00pm Mountain time) Monday through Friday, at 303-651-0551. Or e-mail us at support@instrutechinc.com.

 **WARNING!** Contaminated products (e.g. radioactive, toxic, caustic or microbiological hazard) can be detrimental to health and environment. Products returned to InstruTech should be free of harmful substances.

For the safety of our employees, you must download, complete and submit a material disclosure form from our website at www.instrutechinc.com Please use this form to provide a history of the product detailing what gases have been used. We cannot accept products that have been exposed to hazardous materials.

6 Warranty

SELLER warrants that its products are free of defects in workmanship and material and fit for the uses set forth in SELLER's catalog or product specifications, under the normal use and service for which they are intended.

The entire warranty obligation of SELLER is for the repair or replacement, at SELLER's option, of products or parts (examination of which shall disclose to SELLER's satisfaction that it is defective) returned, to SELLER's plant, properly identified within twenty four (24) months (unless otherwise noted) after the date of shipment from InstruTech Plant. BUYER must obtain the approval of SELLER and a return authorization number prior to shipment.

Alteration or removal of serial numbers or other identification marks renders this warranty void. The warranty does not apply to products or components which have been abused, altered, operated outside of the environmental specifications of the product, improperly handled or installed, or units which have not been operated in accordance with SELLER's instructions. Furthermore the warranty does not apply to products that have been contaminated (user assumes the responsibility in conjunction with the process media used), or when the product or part is damaged during the warranty period due to causes other than ordinary wear and tear to the product including, but not limited to, accidents, transportation, neglect, misuse, use of the product for any purpose other than that for which it was designed.

THIS WARRANTY IS EXCLUSIVE AND IN LIEU OF ALL OTHER WARRANTIES, EXPRESS OR IMPLIED, INCLUDING ANY IMPLIED WARRANTY OF MERCHANTABILITY OR FITNESS FOR A PARTICULAR PURPOSE. THIS WARRANTY EXTENDS ONLY IN FAVOR OF THE ORIGINAL BUYER. THE BUYER'S SOLE REMEDY SHALL BE THE REPAIR OR REPLACEMENT, AS IS EXPRESSLY PROVIDED HEREIN, OF ANY WARRANTED DEFECTIVE PRODUCT OR PART, AND UNDER NO CIRCUMSTANCE SHALL SELLER BE LIABLE TO BUYER OR ANYONE ELSE FOR ANY CONSEQUENTIAL DAMAGES TO PERSONS OR PROPERTY, FOR INCIDENTAL DAMAGES OR LOSS OF TIME, FOR ANTICIPATED OR LOST PROFITS, OR ANY OTHER LOSS INCURRED BY THE BUYER RELATED TO THE PRODUCT COVERED BY THIS WARRANTY. THIS EXCLUSIVE REMEDY SHALL NOT BE DEEMED TO HAVE FAILED OF ITS ESSENTIAL PURPOSE SO LONG AS SELLER IS WILLING AND ABLE TO REPAIR OR REPLACE DEFECTIVE PARTS IN THE PRESCRIBED MANNER. THIS LIMITED WARRANTY MAY NOT BE MODIFIED BY SELLER UNLESS SUCH MODIFICATION OR WAIVER IS IN WRITING, EXECUTED BY AN AUTHORIZED OFFICER OF SELLER.



InstruTech®

1475 S. Fordham St
Longmont, CO 80503
USA

Phone +1-303-651-0551

Fax +1-303-678-1754

E-mail info@instrutechinc.com

www.instrutechinc.com